

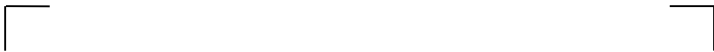

MP[®] Reconstruction Prosthesis

cementless & cementable

Presented by:



Waldemar Link GmbH & Co. KG

Barkhausenweg 10 · 22339 Hamburg, Germany
P.O. Box 63 05 52 · 22315 Hamburg, Germany
Tel.: +49 40 53995-0 · Fax: +49 40 5386929
E-mail: info@linkhh.de · www.linkorthopaedics.com

MP[®] Reconstruction Prosthesis

cementless & cementable

	System Description
02	The Problem
03	Modular Components
06	Expansion Bolts
07	Indications/Contraindications
	Implants
08	Prosthesis Stems, cementless
09	Neck Segments
10	Proximal Spacers, Expansion Bolts
11	Modular Anatomically Curved Revision Stems, cementable
12	Modular Proximal Components
14	Prosthesis Heads
	Instruments
15	Instrument Set, complete
16	Container A
22	Container B, C, D and MP [®] Expansion Bolts
24	Reamers
	Accessories
30	Additional Instruments
30	X-ray Templates
30	Instructions of Cleaning and Maintenance
31	Thabe Titanium Cerclage Band
	Literature
32	MEGASYSTEM-C [®]
33	Medical Reprints
34	Index
	Important Information

■ The Problem

In recent years there has been a sharp increase in the number of cases of femoral-stem loosening involving extensive, generally proximal, femoral defects necessitating stem revision, particularly among younger patients.

Clinical experience has shown that the use of long cemented stems in revision hip arthroplasty in patients with extensive proximal bone loss produces good short-term to medium-term results. However, the use of cement to “plug” bone defects does not tend to promote positive bone remodeling of the damaged proximal femur. In other words, the long-term durability of cemented arthroplasty is not without its problems. In contrast, cementless stems have proven to be successful in such cases.

Porous-coated **cementless femoral stems** have proven to provide stable distal fixation without impeding bone remodeling in the proximal femur. However, fully coated one-piece stems are consi-

dered to be too stiff in the larger sizes and promote ingrowth that is often associated with difficult removal. In addition, these stems may not always adequately address some of the other issues that can arise when revising hip stems. Often times problems such as proximal/distal femoral mismatch, leg length discrepancies, anteversion adjustment and stem removal are better addressed by modular hip stems.

The **MP[®] Reconstruction Prosthesis** is a modular cementless femoral stem that is designed for the revision of failed hip stems in cases of extensive proximal bone loss. Modular proximal and distal stem components better address size mismatch. Tapered fluted stems offer less stiffness. The microporous surface, also available with HX[®] Coating (calcium phosphate), promotes bone ongrowth. The proximal neck segment can be positioned for optimal anteversion. Leg length can be adjusted with proximal spacers.

■ Modular Components

The MP[®] Reconstruction Prosthesis consists of the following components:

- **Femoral heads**
 - CoCrMo alloy or aluminum oxide ceramic or high purity alumina matrix with zirconia reinforcement
 - 28, 32 and 36 mm head diameters with up to 4 neck lengths
- **Neck segments**
 - Tilastan[®] titanium alloy
 - 35 mm and 65 mm
 - Collared/collarless
 - 126° and 135° CCD angle
 - Standard or additional lateral offset
- **Proximal Spacers (optional)**
 - CoCrMo alloy
 - Leg-length adjustment 10, 20 or 30 mm
- **Stems**
 - Tilastan[®] titanium alloy
 - 6 stem lengths: 160, 180, 210, 250, 290 and 330 mm
 - 7 diameters: 12, 14, 16, 18, 20, 22.5 and 25 mm
- **Expansion bolts**
 - CoCrMo alloy
 - To secure the neck segment, spacer and stem assembly

System Description

Modular Components



Expansion bolts
41+61 mm



Prosthesis heads A
BILOX® forte*
3 head-neck lengths
Ø 28, 32, 36 mm



Prosthesis heads A
BILOX® delta*
4 head-neck lengths
Ø 28, 32, 36 mm



Prosthesis heads B
CoCrMo alloy
4 head-neck lengths
Ø 28+32 mm

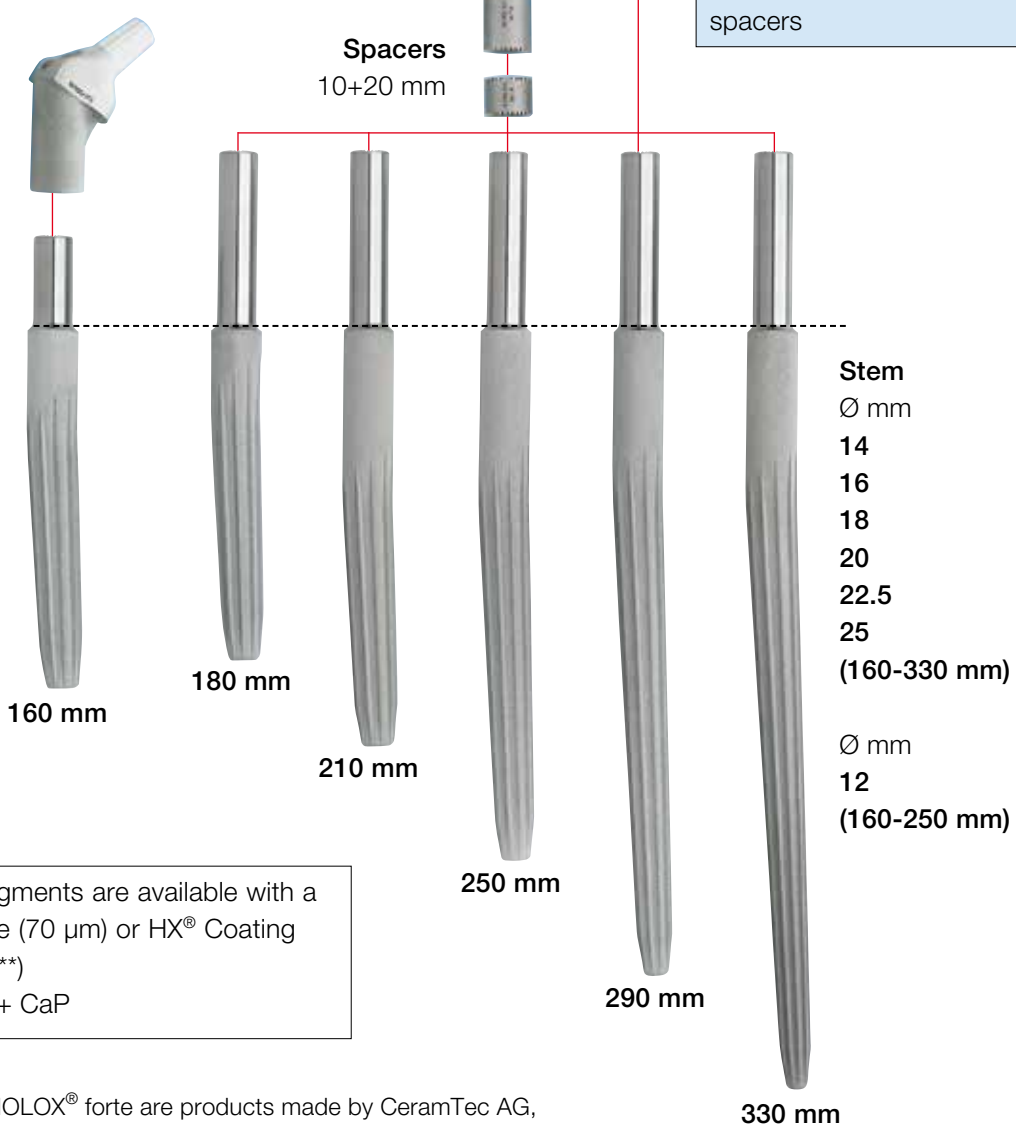
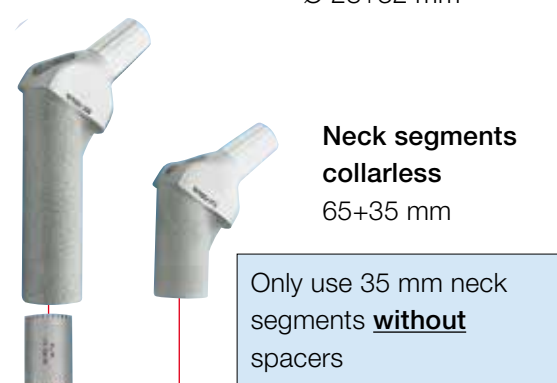
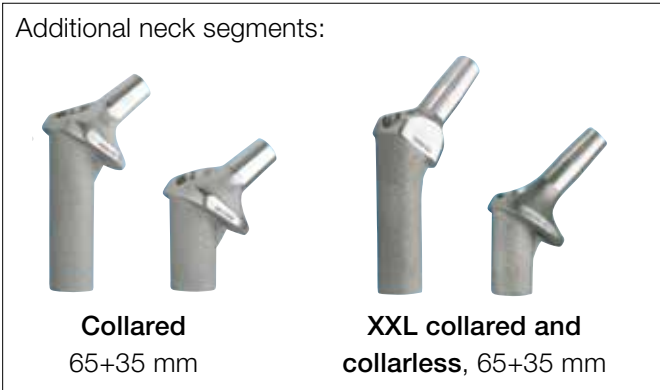

Only use 160 mm stem with 35 mm neck segment and **without** spacers

Stems and neck segments are available with a microporous surface (70 µm) or HX® Coating (calcium phosphate**)
** **TiFastan**® TiAl6V4 + CaP

* BILOX® delta und BILOX® forte are products made by CeramTec AG, Plochingen, Germany

The LINK® MP® Reconstruction Prosthesis system is based on the cementless reconstruction prosthesis designed in 1986 by LINK® in collaboration with the Lubinus-Klinik, Kiel, Germany.

The MP® stem is indicated in revision hip arthroplasty involving cementless reconstruction of the proximal femur in cases of severe bone loss. The MP® stem has also proven to be a success in revisions due to fractures around or below the distal portion of the stem.

The MP® stem can also achieve good results in primary implantations, such as in cases of hip dysplasia, when conventional stems may not be able to adequately provide for the version or leg-length needs of the patient.

The modular MP® stem was designed to provide initial stability in the distal femur coupled with long-term fixation and positive bone remodeling. The stem components are assembled within the prepared femur.

The tapered shape reduces distal stiffness. The 70-micron microporous stem surface, also available with the HX® Coating*, promotes bone ongrowth. The inbuilt 3° angle allows the stem to be implanted in line with the anterior curvature of the femur, centralizes the stem in the femoral canal and reduces rotation. Longitudinal fluting also provides rotational stability and reduces stem stiffness.

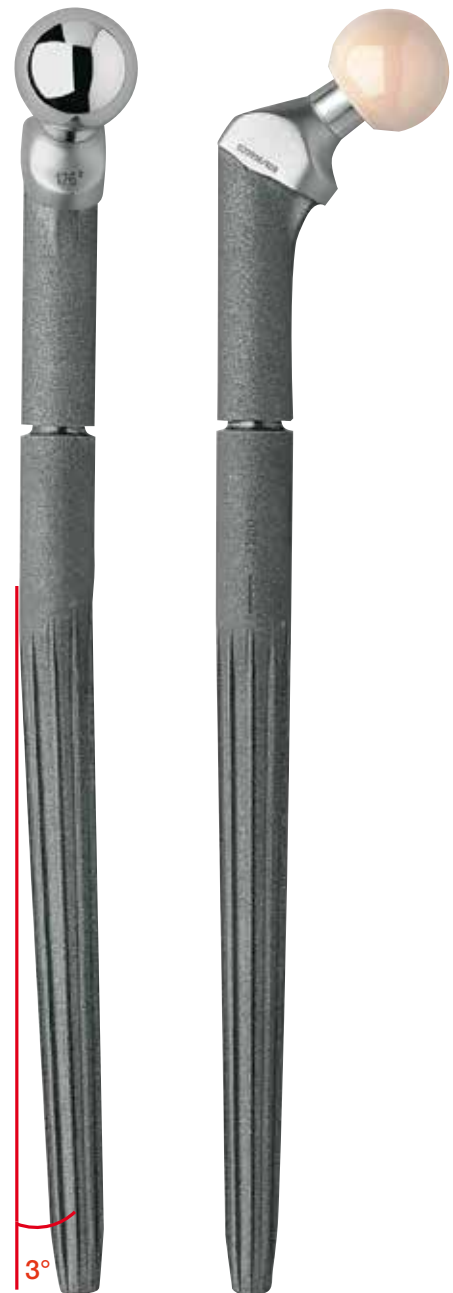

***HX® Coating (calcium phosphate)**

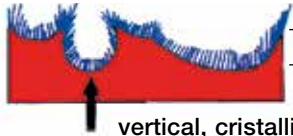

approx. 15 µm

vertical, crystalline coating structure

The HX® Coating is an osteoconductive coating approximately 15 µm thick. The unique electrochemical coating process gives it immense mechanical strength, which is necessary for it to endure the stresses during implantation. The large porous structure provides the optimal environment for bone ongrowth.

The HX® Coating preserves the open-pored structure of the implant surface because it is so thin - thanks to the process of electrochemical coating.

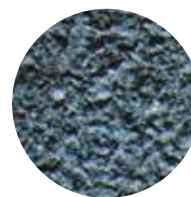

HX® Coating*

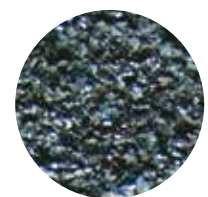

Microporous surface 70 µm surface roughness

System Description

The teeth at the proximal end of the stem and inside the neck segment, together with the fixation screw, securely connect the modular components. The upper part of the stem has a tapped hole to accommodate the fixation screw.

The **neck segment** is the proximal component of the assembly. It is available with or without a collar. The body of the neck segment has a round cross-section with a microporous surface or a HX® Coating* (see page 4). The 35 mm neck segments are used in cases when there is adequate proximal bone to be saved. The 65 mm neck segments are used in femurs with large proximal bone defects and when spacers are used for leg-length correction.

Neck segments are available in a choice of two CCD angles: 126 degrees or 135 degrees. "Standard" and "XXL" lateral offsets are available with both CCD angles.

The teeth inside the neck segment interface with the teeth on the stem. Once the neck segment is connected to the stem, the fixation screw fastens the coupling. This fixation mechanism allows anteversion to be adjusted exactly for each patient, regardless of the position of the stem within the femoral canal.

Anteversion, leg length and lateralization adjustments are made as indicated, without having to break the taperlock or remove the stem once it is in situ.

The stem taper is 12/14 mm to accommodate LINK® femoral heads with a 12/14 mm female taper.

Note!

- 65 mm neck segments may be used with spacers.
- 35 mm neck segments must not be used with spacers.

Proximal spacers for leg-length correction are inserted between the proximal end of the stem and the neck segment, if required. The spacers, which are available in heights of 10 and 20 mm, can be combined to add up to 30 mm of leg length. The teeth of the spacers fit the teeth on the stem and inside the neck segment.

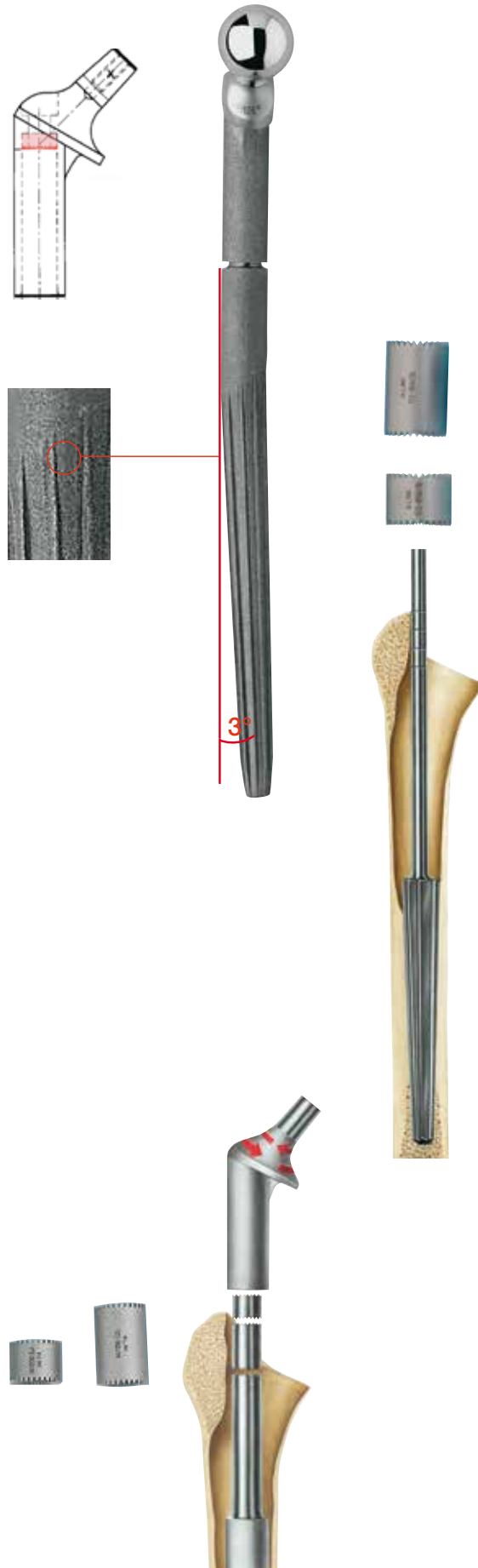

■ Expansion Bolts

The stem, any spacers and the neck segment are connected with either a 41 mm or 61 mm expansion bolt (A), depending on the neck-segment length and the number of spacers (Fig. I).

The expansion bolts securely fix the MP® neck segments to the modular MP® stems.

Note!
LINK® implants and expansion bolts are solely designed for single use. They cannot be reused. The torque wrench comes with a calibration certificate. The torque wrench must be tested after 250 applications, for which the instrument must be sent to WALDEMAR LINK GmbH & Co. KG. The torque wrench must never be used to undo screw connections, since this could damage it. Plastic-sleeve integrity must be checked prior to use.

Warning:

Two bolt lengths are available: 41 and 61 mm

- The 41 mm bolt is used if no spacer or one 10 mm spacer is used.
- The 61 mm bolt is used if one 20 mm spacer is used or a 10 mm spacer is used in conjunction with a 20 mm spacer (overall height: 30 mm)



Surgical technique, correction

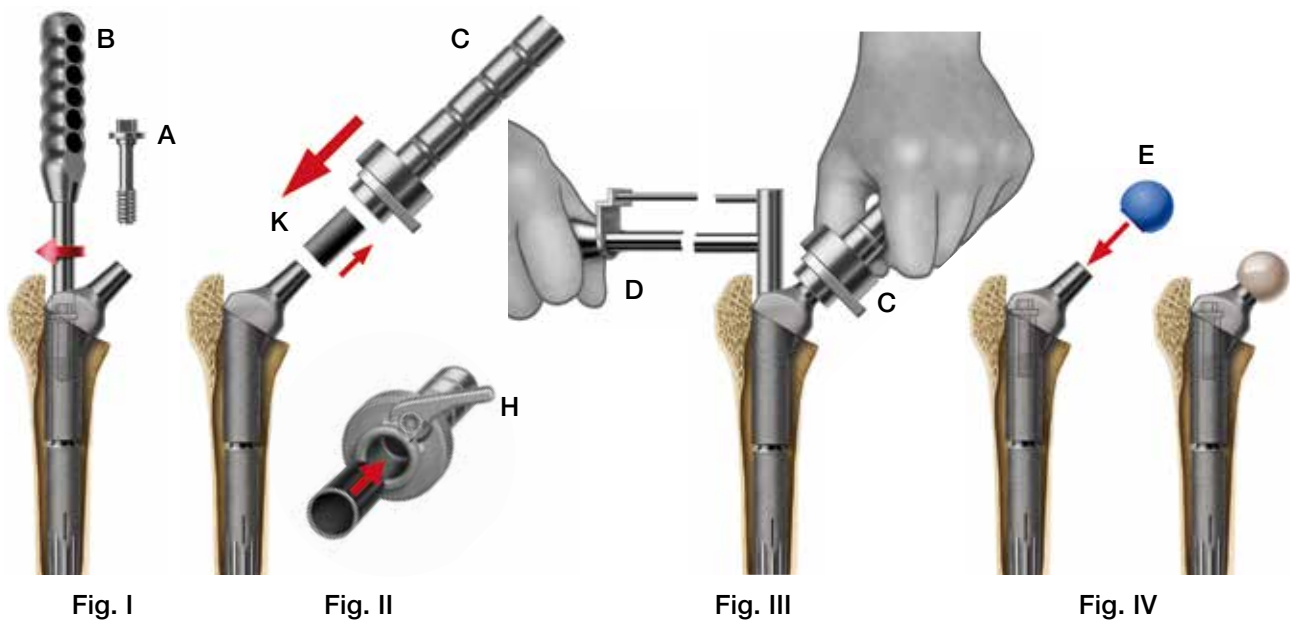

Using the screwdriver (B), the expansion bolt (A) is screwed in as far as it will go and lightly tightened (Fig. I). Then the holder (C) with plastic sleeve (K)

is attached to the taper of the neck segment and fastened by actuating the lever (H) (Fig. II).

■ System Description – Indications/Contraindications

Using the torque wrench (D) (Fig. III), the inserted expansion bolt is tightened as far as short mark 1 on the scale. While tightening, keep a firm grip on both the holder and the torque wrench to ensure that the neck segment remains in situ without rotation. Tightening the expansion bolt as far as short mark 1 on the scale corresponds to a tightening torque of 14.5 to 16.3 Nm. The resulting elastic expansion of the bolt effectively fastens the connection.

The trial head (E) is placed on the taper of the neck segment and a final trial reduction performed to check anteversion (Fig. IV).

Prosthesis heads are available in CoCrMo alloy or aluminum oxide ceramic. They have a female taper of 12/14 mm and can be combined with the 12/14 mm taper of the MP® neck segments. The different head-neck lengths of the available femoral heads affect both leg length and lateralization.

LINK® prosthesis heads are available in diameters of 24 mm (only CoCrMo), 28 mm, 32 mm and 36 mm. Other diameters, such as 22 mm and 26 mm, are available on request.

Instrumentation and trials are supplied in specially assembled trays. They facilitate a precise surgical technique for optimal fixation, leg-length and version adjustment.

- **Reamers** to prepare the femoral canal – which are 2 mm smaller in diameter than the respective MP® stem (external diameter) – are provided for each MP® stem length. Reamers are color-coded by length and the diameter is clearly marked for easy identification.
- The **stem inserter** helps ensure optimal positioning of the stem and alignment of the 3 degree angle of the stem with the curvature of the femur.
- **Trial neck segments, spacers, fixation screws and femoral heads** are provided to determine optimal leg length, lateralization and version.
- The **go/no-go guide** ensures full seating of the neck segment on the implanted stem (incl. any spacers).
- If necessary, the **stem can be removed** with the **special extraction tool**.

■ Indications/Contraindications

Note: Specified indications/contraindications see catalog:
LINK® MP® Reconstruction Prosthesis, Surgical Technique

■ Cementless Prosthesis Stems



Item no. microporous	Item no. HX®*	Size	Prox. stem Ø mm	Dist. stem Ø mm	Length mm
172-916/12	172-917/12	X S-0	12	10	160
172-916/14	172-917/14	X S-1	14	12	160
172-916/16	172-917/16	X S-2	16	14	160
172-916/18	172-917/18	X S-3	18	16	160
172-916/20	172-917/20	X S-4	20	18	160
172-916/22	172-917/22	X S-5	22.5	20.5	160
172-916/25	172-917/25	X S-6	25	23	160
172-918/12	172-919/12	S-0	12	10	180
172-918/14	172-919/14	S-1	14	12	180
172-918/16	172-919/16	S-2	16	14	180
172-918/18	172-919/18	S-3	18	16	180
172-918/20	172-919/20	S-4	20	18	180
172-918/22	172-919/22	S-5	22.5	20.5	180
172-918/25	172-919/25	S-6	25	23	180
172-921/12	172-922/12	00	12	10	210
172-921/14	172-922/14	001	14	12	210
172-921/16	172-922/16	002	16	14	210
172-921/18	172-922/18	003	18	16	210
172-921/20	172-922/20	004	20	18	210
172-921/22	172-922/22	005	22.5	20.5	210
172-921/25	172-922/25	006	25	23	210
172-925/12	172-926/12	0	12	8.5	250
172-925/14	172-926/14	01	14	10.5	250
172-925/16	172-926/16	02	16	12.5	250
172-925/18	172-926/18	03	18	14.5	250
172-925/20	172-926/20	04	20	16.5	250
172-925/22	172-926/22	05	22.5	19	250
172-925/25	172-926/25	06	25	21.5	250
172-929/14	172-931/14	1	14	9	290
172-929/16	172-931/16	2	16	11	290
172-929/18	172-931/18	3	18	13	290
172-929/20	172-931/20	4	20	15	290
172-929/22	172-931/22	5	22.5	17.5	290
172-929/25	172-931/25	6	25	20	290
172-930/14	172-932/14	7	14	7.5	330
172-930/16	172-932/16	8	16	9.5	330
172-930/18	172-932/18	9	18	11.5	330
172-930/20	172-932/20	10	20	13.5	330
172-930/22	172-932/22	11	22.5	16	330
172-930/25	172-932/25	12	25	18.5	330

Stems with a length of less than 160 mm must only be used with short neck segments and without proximal spacers.

Material: Tilastan®

*HX® Coating (see page 4)

■ Implants

■ Neck Segments

Neck segments without collar, taper 12/14 mm

Material: Tilastan®

Item no. microporous	Item no. HX®*	Length mm	CCD angle
172-964/26	172-966/26	65	126°
172-964/35	172-966/35	65	135°
172-965/26	172-967/26	35	126°
172-965/35	172-967/35	35	135°



Neck segments with collar, taper 12/14 mm

Material: Tilastan®

Item no. microporous	Item no. HX®*	Length mm	CCD angle
172-960/26	172-962/26	65	126°
172-960/35	172-962/35	65	135°
172-961/26	172-963/26	35	126°
172-961/35	172-963/35	35	135°



Neck segments XXL without collar (with 40 mm offset)

taper 12/14 mm

Material: Tilastan®

Item no. microporous	Item no. HX®*	Length mm	CCD angle
172-984/26	172-986/26	65	126°
172-984/35	172-986/35	65	135°
172-985/26	172-987/26	35	126°
172-985/35	172-987/35	35	135°



Neck segments XXL with collar (with 40 mm offset), taper 12/14 mm

Material: Tilastan®

Item no. microporous	Item no. HX®*	Length mm	CCD angle
172-980/26	172-982/26	65	126°
172-980/35	172-982/35	65	135°
172-981/26	172-983/26	35	126°
172-981/35	172-983/35	35	135°



* HX® Coating (see page 4)

■ **Proximal Spacers**

Material: CoCrMo alloy

Item no.	Length mm
172-950/10	10
172-950/20	20



■ **Expansion Bolts**

Material: CoCrMo alloy

Item no.	Length mm
172-947/38	41 (short)
172-947/58	61 (long)



Combinations

Neck segments	Proximal spacers		Elongation	Expansion bolt
	10 mm	20 mm		
Length mm				
65	-	-	0	41 (short)
65	10	-	10	41 (short)
65	-	20	20	61 (long)
65	10	20	30	61 (long)
35 ¹⁾	-	-	-	41 (short)

1) Cannot be used in conjunction with spacer(s).

■ Implants

■ Cementable Modular Anatomically Curved Revision Stems

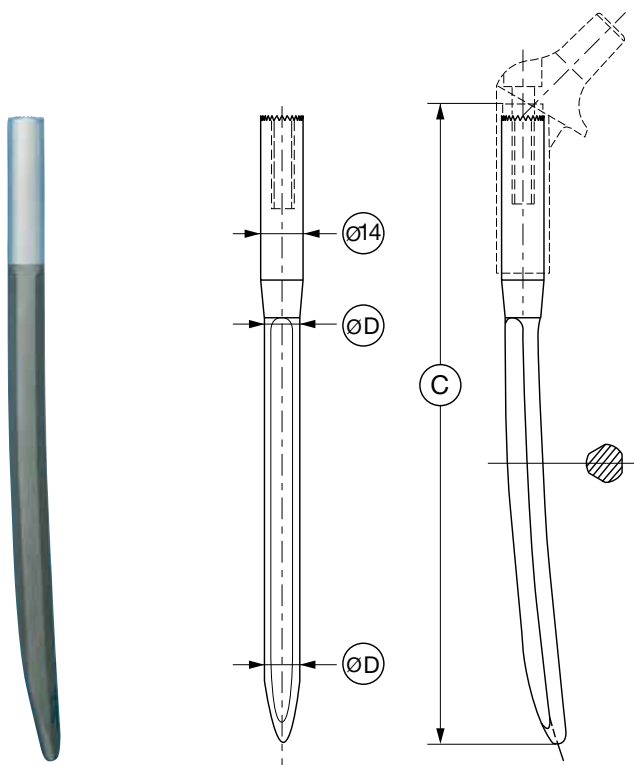

Prosthesis stems, cementable

Material: CoCrMo alloy

Item no.	For stem length (C) mm	Stem Ø (D) mm
172-900/12	200	12
172-900/14	200	14
172-900/16	200	16
172-901/12	240	12
172-901/14	240	14
172-901/16	240	16
172-902/12	280	12
172-902/14	280	14
172-902/16	280	16
172-903/12	320	12
172-903/14	320	14
172-903/16	320	16

The modular anatomically curved revision stems are compatible with all MP® neck segments (page 9)

■ **Modular Proximal Components for MP® Reconstruction Prostheses**



The MP® Reconstruction Prosthesis facilitates modular replacement of the proximal femur by virtue of the modular proximal components. Proximal femoral bone deficits of between 40 and 130 mm can be compensated for by combining base components with UHMWPE extensions and terminals. The terminals, which are made of *Ti/otan*® titanium alloy, are designed to be seated on the proximal resection plane of the femur. To achieve stable fixation, the stem below the terminal should be at least 180 mm in length. Of course, the longer the implant, the greater the diameter of the stem should be.

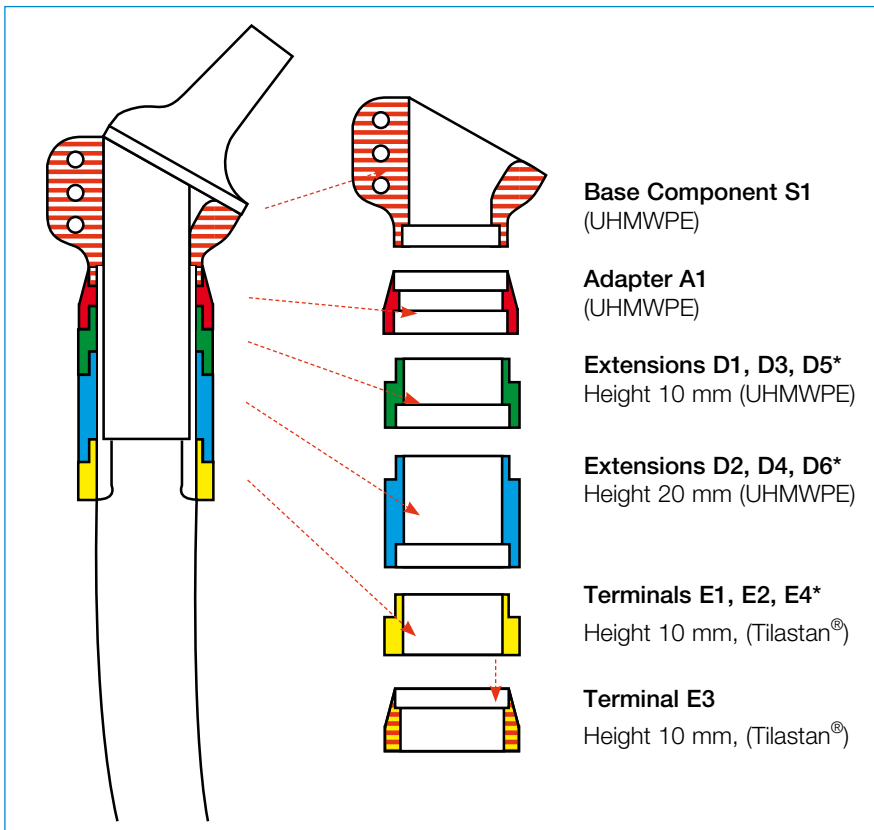

The internal diameter of the extensions and terminals correspond to the external diameter of the neck segment and stems. Therefore, they may only be used in the combinations given in the following table (page 13).

* The Extensions D1 and D2 as well as the Terminal E1 may only be used if the modular collar set-up exceeds 70 mm of length.

Possibilities of Combination: Modular UHMWPE Collar											
Materials Base Component and Extensions and Adapter: UHMWPE, Terminals: Titalan® TiAl6V4											
Prosthesis Stem Dia.:											
Ø 14 mm - Ø 16 mm		Ø 18 mm - Ø 20 mm		Ø 22 mm - Ø 25 mm		Terminal		Terminal			
Extensions		Terminal		Extensions		Terminal		Extensions		Terminal	
Item No.	Item No.	Item No.	Item No.	Item No.	Item No.	Item No.	Item No.	Item No.	Item No.	Item No.	Item No.
172-971/10	172-971/20	172-974/01	172-972/10	172-972/20	172-974/02	172-972/10	172-972/20	172-973/10	172-973/20	172-974/03	172-974/04
<p style="text-align: center;">for Total Length</p>											
40 mm	1	-	-	-	1	-	-	-	-	1	-
50 mm	1	-	-	1	1	-	-	-	-	-	1
60 mm	1	-	-	-	1	1	1	-	1	-	1
70 mm	1	-	-	1	1	1	1	-	-	1	1
80 mm	1	-	-	1	2	-	2	-	1	1	1
90 mm	1	-	-	1	2	1	2	-	1	1	1
100 mm	1	1	-	1	2	-	3	-	1	1	1
110 mm	1	1	-	1	2	1	3	-	-	1	1
120 mm	1	2	-	1	2	-	4	-	1	1	1
130 mm	1	2	-	1	2	1	4	-	-	1	1

■ **Prosthesis Heads**

Prosthesis heads A - forte

Material: BIOLOX® forte*



Item no.	Head Ø mm	Taper mm	Neck length (mm)
128-928/01	28	12/14	short (-3.5)
128-928/02	28	12/14	medium (0)
128-928/03	28	12/14	long (+3.5)
128-932/01	32	12/14	short (-4.0)
128-932/02	32	12/14	medium (0)
128-932/03	32	12/14	long (+4.0)
128-936/01	36	12/14	short (-4.0)
128-936/02	36	12/14	medium (0)
128-936/03	36	12/14	long (+4.0)

Prosthesis heads A - delta

Material: BIOLOX® delta*



Item no.	Head Ø mm	Taper mm	Neck length (mm)
128-791/01	28	12/14	short (-3.5)
128-791/02	28	12/14	medium (0)
128-791/03	28	12/14	long (+3.5)
128-792/01	32	12/14	short (-4.0)
128-792/02	32	12/14	medium (0)
128-792/03	32	12/14	long (+4.0)
128-792/04**	32	12/14	extra long (+7)
128-793/01	36	12/14	short (-4.0)
128-793/02	36	12/14	medium (0)
128-793/03	36	12/14	long (+4.0)
128-793/04**	36	12/14	extra long (+8.0)

All components made of BIOLOX® forte and BIOLOX® delta are compatible with each other.

Prosthesis heads B

Material: CoCrMo alloy



Item no.	Head Ø mm	Taper mm	Neck length (mm)
128-826/01	26	12/14	short (-3.5)
128-826/02	26	12/14	medium (0)
128-826/03	26	12/14	long (+3.5)
128-828/01	28	12/14	short (-3.5)
128-828/02	28	12/14	medium (0)
128-828/03	28	12/14	long (+3.5)
128-828/04**	28	12/14	extra long (+10.5)
128-832/01	32	12/14	short (-4.0)
128-832/02	32	12/14	medium (0)
128-832/03	32	12/14	long (+4.0)
128-832/04**	32	12/14	extra long (+8.5)

* BIOLOX® delta and BIOLOX® forte are made by CeramTec AG, Plochingen, Germany

** on request

Instruments

A

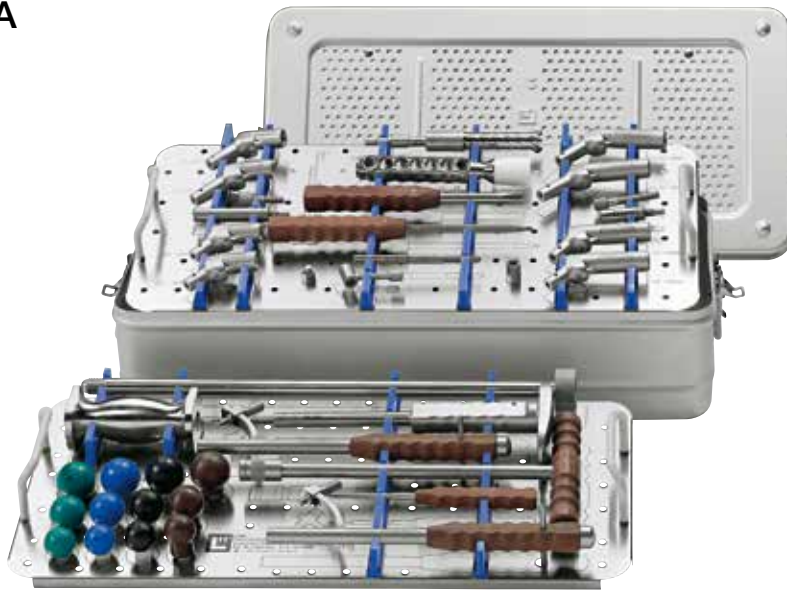

B



C



D

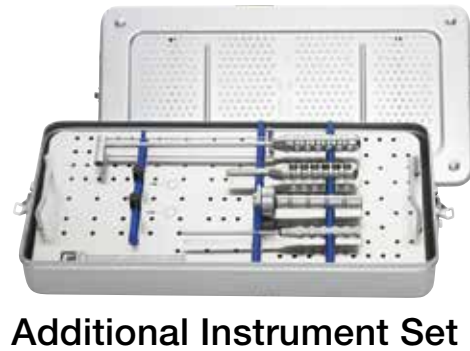

Additional Instrument Set

Item no.	Instrument set, complete (incl. Container A, B and C)
131-340/05	Set in 3 containers, consisting of:
131-341/15	Container A
131-342/01	Container B
131-343/01	Container C
131-344/01*	Container D
131-340/04*	Additional instrument set for expansion bolts

*not included in the instrument set, complete

Content:

131-341/15 Container A		Qty.
05-2002/03 N21 Standard container 575 x 275 x 130 mm		1
131-341/09 Upper tray, empty 550 x 265 x 50 mm		1
131-380/01 Stem inserter 275 mm		1
131-380/02 Threaded rod with slap hammer for 131-380/01, 450 mm		1
10-5373 Hex screwdriver hex 2.5 mm, for 131-380/01 180 mm		1
130-408/05 Handle for tapered reamers fitting optional, 300 mm		1

How to order: 130-408/05B = with Fitting Hudson

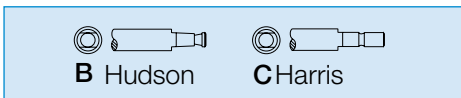

131-378/05 Inserter for neck segments "standard" and "short", 280 mm		1
131-378/06 Inserter for neck segments XXL "standard" and "short", 280 mm		1
131-341/08 Lower tray, empty 550 x 265 x 50 mm		1
131-377/01 Guide rod, calibrated 120 mm		1
64-8008 Hex screwdriver hex 3.5 mm, 250 mm		1
131-376 Go/no go guide, 60 mm		1
131-385 Cross-slot screwdriver 210 mm		1

Drill guide with stop for neck segments			
Item no.	Length mm	For neck segments	Qty.
131-383	60	standard (L 65 mm)	1
131-383/90	90	short (L 35 mm)	1

131-384/01 Tubular reamer fitting Jacobs Chuck, 175 mm		1
130-600 Driver for prosthesis heads, 170 mm		1

Trial neck segments with taper 12/14 mm				
Item no.	Length mm	Version	CCD angle	Qty.
131-395/26	35	short	126°	1
131-395/35	35	short	135°	1
131-396/26	65	standard	126°	1
131-396/35	65	standard	135°	1

Trial neck segments XXL with taper 12/14 mm				
Item no.	Length mm	Version	CCD angle	Qty.
131-393/26	35	short	126°	1
131-393/35	35	short	135°	1
131-394/26	65	standard	126°	1
131-394/35	65	standard	135°	1

Trial proximal spacers		
Item no.	Length mm	Qty.
131-398/10	10	1
131-398/20	20	1

Trial fixation screws		
Item no.	Length mm	Qty.
131-397/38	38 (short)	1
131-397/58	58 (long)	1

Colored plastic trial heads			
Item no.	Head Ø mm	Neck length mm	Neck length
131-928/01	28	-3.5	short (S)
131-928/02	28	0	medium (M)
131-928/03	28	+3.5	long (L)
131-928/04	28	+10.5	extra long (XL)
optional			
131-932/01	32	-4	short (S)
131-932/02	32	0	medium (M)
131-932/03	32	+4	long (L)
131-932/04	32	+8.5	extra long (XL)
optional			
131-936/01	36	-4	short (S)
131-936/02	36	0	medium (M)
131-936/03	36	+4	long (L)
131-936/04	36	+8	extra long (XL)

■ Instruments



05-2002/03 N21 Standard Container

575 x 275 x 130 mm
base (closed) and lid, made of aluminium,
incl. set of 5 disposable filters and 10 disposable
plastic seals



131-380/01

Stem inserter for MP® stems, 275 mm



131-380/02

Threaded rod with slaphammer for stem extraction in combination
with stem inserter 131-380/01, 450 mm

Screw for dismantling



131-380/01 Stem inserter



10-5373

Hex screwdriver

hex 2.5 mm, disassemble stem inserter, 180 mm



Threaded rod with slap hammer, stem inserter, MP® stem



130-408/05

Handle for reamers, can be dismantled fittings optional, 300 mm

How to order:

130-408/05B = with fitting Hudson

	
B Hudson	C Harris



131-385

Cross-slot screwdriver

210 mm







Drill guide with stop for neck segments

Item no.	Length mm	For neck segments
131-383	60	standard
131-383/90	90	short



131-384/01

Tubular reamer with external chip disposal, 175 mm, for neck segments with taper, fitting Jacobs Chuck **E**

			
A Jacobs Chuck	B Hudson	C Harris	D AO

optional:

131-384/02	B Hudson-fitting
131-384/03	D AO-fitting
131-384/04	C Harris-fitting

■ Instruments



130-600

Driver for prosthesis heads
170 mm

130-601

Replacement head for 130-600
(not included in instrument set)

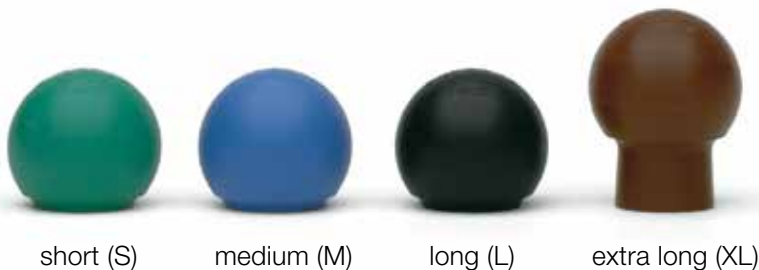

Colored plastic trial heads
available alternatively
in 28, 32 or 36 mm

short (S)

medium (M)

long (L)

extra long (XL)

Colored plastic trial heads for trial neck segments and implants

Item no.	Head Ø mm	Neck length	Neck length mm	Color
131-928/01	28	short (S)	-3.5	green
131-928/02	28	medium (M)	0	blue
131-928/03	28	long (L)	+3.5	black
131-928/04	28	extra long (XL)	+10.5	brown
131-932/01	32	short (S)	-4	green
131-932/02	32	medium (M)	0	blue
131-932/03	32	long (L)	+4	black
131-932/04	32	extra long (XL)	+8.5	brown
131-936/01	36	short (S)	-4	green
131-936/02	36	medium (M)	0	blue
131-936/03	36	long (L)	+4	black
131-936/04	36	extra long (XL)	+8	brown



Trial neck segments with taper 12/14 mm

Item no.	Length mm	CCD angle
131-395/26	35	126°
131-395/35	35	135°
131-396/26	65	126°
131-396/35	65	135°



Trial proximal spacers

Item no.	Length mm
131-398/10	10
131-398/20	20



Trial neck segments XXL (with 40 mm offset)
with taper 12/14 mm

Item no.	Length mm	CCD angle
131-393/26	35	126°
131-393/35	35	135°
131-394/26	65	126°
131-394/35	65	135°



Trial fixation screws

Item no.	Length mm
131-397/38	38
131-397/58	58

■ Instruments



Inserter for neck segments

280 mm

Item no.	For neck segments
131-378/05	35+65 mm
131-378/06	35+65 mm (XXL)



131-377/01

Guide rod, calibrated for positioning of neck segments, 120 mm



64-8008

Hex screwdriver

hex 3.5 for tightening guide rod
131-377/01, 250 mm



MP® stem, guide rod, MP® neck segment, inserter



Guide rod,
go/no go guide,
MP® neck segment,
MP® stem



131-376

Go/no go guide to control engagement of neck segment teeth with stem teeth, 60 mm



131-342/01 Container B

consisting of: Qty.

- 05-2002/03 N21 Standard container**
575 x 275 x 130 mm 1
- 131-342/02 Upper tray, empty** 1
with product illustrations
(green color-coding)
550 x 265 x 50 mm

Tapered reamer with Harris fitting with **green** color-coding
(Diameter 12; 14; 16; 18; 20; 22.5; 25 mm)

Item no.	Length mm	For stem sizes	Unit
131-386/50	390	001-006/ 210 mm	1 set

- 131-342/03 Lower tray, empty** 1
with product illustrations
(blue color-coding)
550 x 265 x 50 mm

Tapered reamer with Harris fitting with **blue** color-coding
(Diameter 12; 14; 16; 18; 20; 22.5; 25 mm)

Item no.	Length mm	For stem sizes	Unit
131-388/50	430	01-06/ 250 mm	1 set

Optional fittings for tapered reamers:
Hudson or AO

131-343/01 Container C

consisting of: Qty.

- 05-2002/03 N21 Standard container**
575 x 275 x 130 mm 1
- 131-343/02 Upper tray, empty** 1
with product illustrations
(black color-coding)
550 x 265 x 50 mm

Tapered reamer with Harris fitting with **black** color-coding
(Diameter 12; 14; 16; 18; 20; 22.5; 25 mm)

Item no.	Length mm	For stem sizes	Unit
131-390/50	470	1-6/ 290 mm	1 set

- 131-343/03 Lower tray, empty** 1
with product illustrations
(brown color-coding)
550 x 265 x 50 mm

Tapered reamer with Harris fitting with **brown** color-coding
(Diameter 12; 14; 16; 18; 20; 22.5; 25 mm)

Item no.	Length mm	For stem sizes	Unit
131-392/50	510	7-12/ 330 mm	1 set

Optional fittings for tapered reamers:
Hudson or AO

■ Instruments



131-344/01 Container D

consisting of: Qty.

- 05-2002/03 N21 Standard container** 575 x 275 x 130 mm 1
- 131-344/02 Upper tray, empty** 1
with product illustrations
(yellow color-coding)
550 x 265 x 50 mm

Tapered reamer with Harris fitting with yellow color-coding
(Diameter 12; 14; 16; 18; 20; 22.5; 25 mm)

Item no.	Length mm	For stem sizes	Unit
131-384/50	390	0005-0008, S-8-S-6/ 180 mm	1 set

- 131-344/03 Lower tray, empty** 1
with product illustrations
(red color-coding)
550 x 265 x 50 mm

Tapered reamer with Harris fitting with red color-coding
(Diameter 12; 14; 16; 18; 20; 22.5; 25 mm)

Item no.	Length mm	For stem sizes	Unit
131-382/50	390	X S-0 - 6/ 160 mm	1 set

Optional fittings for tapered reamers:
Hudson or AO

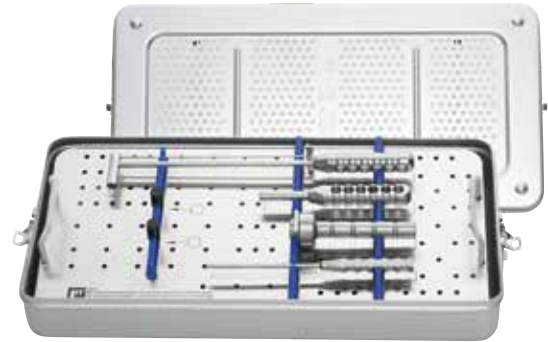





131-340/04 Instrument set for MP® expansion bolts

consisting of: Qty.

- 05-2001/03 N11 Standard container** 575 x 275 x 100 mm 1
- 131-341/10 Tray, empty** 1
with product illustrations,
perforated stainless steel,
550 x 265 x 50 mm
- 131-385/10 Torque wrench** 1
key width 8 mm, 380 mm
- 131-385/01 Screwdriver** 1
key width 8 mm, 185 mm
- 131-378/10 Holder for MP® neck segment** 1
150 mm
- 131-378/20 Hex wrench** 1
hex 5 mm, 244 mm
- 131-378/11 Plastic sleeves for 131-378/10**
Taper 12/14 mm, set of 2 pieces

■ Reamers

Reamer color-coding

-  Tapered reamers 390 mm long for 160 mm stems
-  Tapered reamers 390 mm long for 180 mm stems
-  Tapered reamers 390 mm long for 210 mm stems
-  Tapered reamers 430 mm long for 250 mm stems
-  Tapered reamers 470 mm long for 290 mm stems
-  Tapered reamers 510 mm long for 330 mm stems



Tapered reamers for 160 mm stems with red color-coding

Item no.	Length mm	Diameter mm	For stem sizes	Quantity
----------	-----------	-------------	----------------	----------

with Harris fitting

131-382/50	390	12, 14, 16, 18, 20, 22.5, 25	XS-0 - XS-6	1 set (7 pc.)
consisting of:				
131-382/57	390	12	XS-0	1
131-382/51	390	14	XS-1	1
131-382/52	390	16	XS-2	1
131-382/53	390	18	XS-3	1
131-382/54	390	20	XS-4	1
131-382/55	390	22.5	XS-5	1
131-382/56	390	25	XS-6	1

with AO fitting

131-382/70	390	12, 14, 16, 18, 20, 22.5, 25	XS-0 - XS-6	1 set (7 pc.)
consisting of:				
131-382/77	390	12	XS-0	1
131-382/71	390	14	XS-1	1
131-382/72	390	16	XS-2	1
131-382/73	390	18	XS-3	1
131-382/74	390	20	XS-4	1
131-382/75	390	22.5	XS-5	1
131-382/76	390	25	XS-6	1

with Hudson fitting

131-382/80	390	12, 14, 16, 18, 20, 22.5, 25	XS-0 - XS-6	1 set (7 pc.)
consisting of:				
131-382/87	390	12	XS-0	1
131-382/81	390	14	XS-1	1
131-382/82	390	16	XS-2	1
131-382/83	390	18	XS-3	1
131-382/84	390	20	XS-4	1
131-382/85	390	22.5	XS-5	1
131-382/86	390	25	XS-6	1



Tapered reamers for 180 mm stems with yellow color-coding

Item no.	Length mm	Diameter mm	For stem sizes	Quantity
with Harris fitting				
131-384/50	390	12, 14, 16, 18, 20, 22.5, 25	S0-S6	1 set (7 pc.)
consisting of:				
131-384/57	390	12	S-0	1
131-384/51	390	14	S-1	1
131-384/52	390	16	S-2	1
131-384/53	390	18	S-3	1
131-384/54	390	20	S-4	1
131-384/55	390	22.5	S-5	1
131-384/56	390	25	S-6	1
with AO fitting				
131-384/70	390	12, 14, 16, 18, 20, 22.5, 25	S0-S6	1 set (7 pc.)
consisting of:				
131-384/77	390	12	S-0	1
131-384/71	390	14	S-1	1
131-384/72	390	16	S-2	1
131-384/73	390	18	S-3	1
131-384/74	390	20	S-4	1
131-384/75	390	22.5	S-5	1
131-384/76	390	25	S-6	1
with Hudson fitting				
131-384/80	390	12, 14, 16, 18, 20, 22.5, 25	S0-S6	1 set (7 pc.)
consisting of:				
131-384/87	390	12	S-0	1
131-384/81	390	14	S-1	1
131-384/82	390	16	S-2	1
131-384/83	390	18	S-3	1
131-384/84	390	20	S-4	1
131-384/85	390	22.5	S-5	1
131-384/86	390	25	S-6	1



Tapered reamers for 210 mm stems with green color-coding

Item no.	Length mm	Diameter mm	For stem sizes	Quantity
----------	-----------	-------------	----------------	----------

with Harris fitting

131-386/50	390	12, 14, 16, 18, 20, 22.5, 25	000-006	1 set (7 pc.)
consisting of:				
131-386/57	390	12	000	1
131-386/51	390	14	001	1
131-386/52	390	16	002	1
131-386/53	390	18	003	1
131-386/54	390	20	004	1
131-386/55	390	22.5	005	1
131-386/56	390	25	006	1

with AO fitting

131-386/70	390	12, 14, 16, 18, 20, 22.5, 25	00-006	1 set (7 pc.)
consisting of:				
131-386/77	390	12	000	1
131-386/71	390	14	001	1
131-386/72	390	16	002	1
131-386/73	390	18	003	1
131-386/74	390	20	004	1
131-386/75	390	22.5	005	1
131-386/76	390	25	006	1

with Hudson fitting

131-386/80	390	12, 14, 16, 18, 20, 22.5, 25	000-006	1 set (7 pc.)
consisting of:				
131-386/87	390	12	000	1
131-386/81	390	14	001	1
131-386/82	390	16	002	1
131-386/83	390	18	003	1
131-386/84	390	20	004	1
131-386/85	390	22.5	005	1
131-386/86	390	25	006	1



Tapered reamers for 250 mm stems with blue color-coding

Item no.	Length mm	Diameter mm	For stem sizes	Quantity
with Harris fitting				
131-388/50	430	12, 14, 16, 18, 20, 22.5, 25	00-06	1 set (7 pc.)
consisting of:				
131-388/57	430	12	00	1
131-388/51	430	14	01	1
131-388/52	430	16	02	1
131-388/53	430	18	03	1
131-388/54	430	20	04	1
131-388/55	430	22.5	05	1
131-388/56	430	25	06	1
with AO fitting				
131-388/70	430	12, 14, 16, 18, 20, 22.5, 25	00-06	1 set (7 pc.)
consisting of:				
131-388/77	430	12	00	1
131-388/71	430	14	01	1
131-388/72	430	16	02	1
131-388/73	430	18	03	1
131-388/74	430	20	04	1
131-388/75	430	22.5	05	1
131-388/76	430	25	06	1
with Hudson fitting				
131-388/80	430	12, 14, 16, 18, 20, 22.5, 25	00-06	1 set (7 pc.)
consisting of:				
131-388/87	430	12	00	1
131-388/81	430	14	01	1
131-388/82	430	16	02	1
131-388/83	430	18	03	1
131-388/84	430	20	04	1
131-388/85	430	22.5	05	1
131-388/86	430	25	06	1



Tapered reamers for 290 mm stems with black color-coding

Item no.	Length mm	Diameter mm	For stem sizes	Quantity
with Harris fitting				
131-390/50	470	12, 14, 16, 18, 20, 22.5, 25	1-6	1 set (7 pc.)
consisting of:				
131-390/57	470	12	1	1
131-390/51	470	14	1	1
131-390/52	470	16	2	1
131-390/53	470	18	3	1
131-390/54	470	20	4	1
131-390/55	470	22.5	5	1
131-390/56	470	25	6	1
with AO fitting				
131-390/70	470	12, 14, 16, 18, 20, 22.5, 25	1-6	1 set (7 pc.)
consisting of:				
131-390/77	470	12	1	1
131-390/71	470	14	1	1
131-390/72	470	16	2	1
131-390/73	470	18	3	1
131-390/74	470	20	4	1
131-390/75	470	22.5	5	1
131-390/76	470	25	6	1
with Hudson fitting				
131-390/80	470	12, 14, 16, 18, 20, 22.5, 25	1-6	1 set (7 pc.)
consisting of:				
131-390/87	470	12	1	1
131-390/81	470	14	1	1
131-390/82	470	16	2	1
131-390/83	470	18	3	1
131-390/84	470	20	4	1
131-390/85	470	22.5	5	1
131-390/86	470	25	6	1



Tapered reamers for 330 mm stems with brown color-coding

Item no.	Length mm	Diameter mm	For stem sizes	Quantity
with Harris fitting				
131-392/50	510	12, 14, 16, 18, 20, 22.5, 25	7-12	1 set (7 pc.)
consisting of:				
131-392/56	510	12	7	1
131-392/57	510	14	7	1
131-392/58	510	16	8	1
131-392/59	510	18	9	1
131-392/60	510	20	10	1
131-392/61	510	22.5	11	1
131-392/62	510	25	12	1
with AO fitting				
131-392/70	510	12, 14, 16, 18, 20, 22.5, 25	7-12	1 set (7 pc.)
consisting of:				
131-392/77	510	12	7	1
131-392/71	510	14	7	1
131-392/72	510	16	8	1
131-392/73	510	18	9	1
131-392/74	510	20	10	1
131-392/75	510	22.5	11	1
131-392/76	510	25	12	1
with Hudson fitting				
131-392/80	510	12, 14, 16, 18, 20, 22.5, 25	7-12	1 set (7 pc.)
consisting of:				
131-392/87	510	12	7	1
131-392/81	510	14	7	1
131-392/82	510	16	8	1
131-392/83	510	18	9	1
131-392/84	510	20	10	1
131-392/85	510	22.5	11	1
131-392/86	510	25	12	1

■ **Additional Instruments** (not included in instrument set)



Guided osteotome, 250 mm

Item no.	Width mm	Effective length mm
65-1700/20	20	65
65-1700/25	25	65

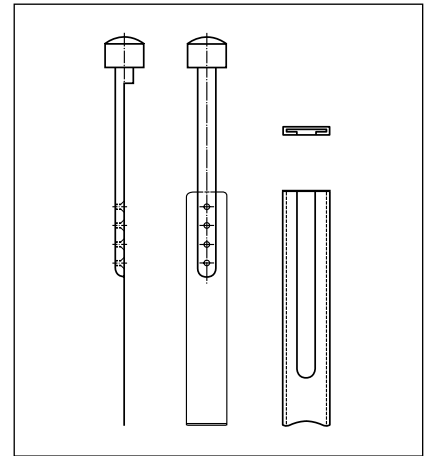

■ **X-ray Templates**

X-ray templates for MP® Reconstruction Protheses
110 % of actual size, taper 12/14 mm, set of 7 sheets

Item no.	CCD angle	Head Ø mm	Neck length	For stem length mm	Set
175-870/02	126°	32	short (S)	160	7 sheets
175-870/05	135°	32	short (S)	160	7 sheets
175-870/08	126°	32	medium (M)	180	7 sheets
175-870/11	135°	32	medium (M)	180	7 sheets
175-870/14	126°	32	long (L)	210 - 330	7 sheets
175-870/17	135°	32	long (L)	210 - 330	7 sheets

(X-ray templates 120 % actual size available on request)

X-ray templates for MP® Reconstruction Protheses, **XXL neck segments with collar**
110 % of actual size, taper 12/14 mm, with neutral head designation, set of 1 sheet

Item no.	CCD angle	Head Ø mm	Neck length	For stem length mm	Set
175-870/41	126°	32	short (S)	160 - 330	1 sheet
175-870/51	135°	32	short (S)	160 - 330	1 sheet

■ **Instructions of Cleaning and Maintenance**

Specific instructions for instruments are available on request via customer@linkhh.de.

■ Accessories

63-4300/02 Titanium Cerclage Band with Lock

Material: Titan, 5.8 mm length, 240 mm



The Thabe titanium cerclage band offers an effective and manageable way of treating all kinds of fracture of the femur. Compared to wire cerclage systems, the wide contact surface of the band distributes compression forces evenly over a wide area and prevents the band from cutting into the bone. The corrugated portion of the cerclage band preserves the periosteal blood supply, which is important for the revitalization of fracture fragments or bone grafts. Titanium is biocompatible, allowing the cerclage band to be left in situ for longer.

Indications

- Post-traumatic fractures of the femur
- Bone fixation after trochanteric osteotomies
- Shaft fractures in primary or revision total hip arthroplasty
- Fixation of bone grafts

Osteosynthesis instrument set for Thabe titanium cerclage band

63-4300/05

Instrument set for Thabe cerclage, complete

consisting of: Qty.

05-1000/01

K1 small container, 460 x 190 x 92 mm 1

63-4300/11

Tray, empty, 415 x 175 x 35 mm 1

63-4300/19

Cerclage band guide
Inner radius 40 mm, 290 mm 1

63-4300/20

Cerclage band guide
Inner radius 50 mm, 300 mm 1

63-4300/40

Cerclage band tightener 1

175-600

Hex screwdriver
hex 3.0 mm, 230 mm 1

64-4300/30

Band tightener plier, with tooth, 170 mm 1



More information on the use of the cerclage band is available on request.

MEGASYSTEM-C® Tumor Replacement Surgery

The modular reconstruction system for tumor surgery, **MEGASYSTEM-C®**, was developed in collaboration with Prof. Dr. Capanna of the Centro Traumatologico Ortopedico in Florence.

With its high degree of modularity, the system facilitates both partial replacement of proximal and distal femoral bone and total replacement of the femur.

For knee arthroplasty, **Endo-Model® SL®** implants are incorporated in the **MEGASYSTEM-C®**. Modularity gives the surgeon the flexibility to address any intra-operative situations that arise.

The system respects biomechanical load and anchoring principles and uses well-established, proven implant components, which makes for absolute reliability and thus good prospects for the surgical outcome.

- Maximum intraoperative flexibility thanks to highly modular implant components, without the expense of a true custom-made implant
- Fully integrated system thanks to compatibility with standard implant systems such as the MP® Hip Revision System and Endo-Model® knee components
- Knee components based on long-term clinical experience with the successful Endo-Model® knee implants
- Long-established and clinically proven coupling mechanics
- Cementable and cementless stems
- Intraoperative length adjustment in 10 mm increments



Catalog MEGASYSTEM-C®

Implants und Instruments

Order number:

909en Impl.

Medical Reprints, available on request:

Ph. Lubinus, W. Klauser *

The Revision Femur: A Potpourri of Options, A Modular Option for Proximal Bone Loss, Orthopaedics, Vol. 23 No. 9, Sept. 2000 [\(H112\)](#)

A. Seth Greenwald, Paul D. Postak

The Influence of Modularity on the Endurance Performance of the LINK® MP® Hip Stem, Orthopaedic Research Laboratories, Cleveland, Ohio, Feb. 2001 [\(H114\)](#)

F. Bellomo, L. Bertignone, L. Morino, P. Milano, E. Schiavone, M. Barale

LINK® MP® cementless distal fixation modular prosthesis for revision total hip arthroplasty, J Orthopaed Traumatol (2002) 2:121-124 ©Springer Verlag 2002 [\(H118\)](#)

Daniel J. Berry, MD

Femoral Revision, Distal Fixation With Fluted, Tapered Grit-Blasted Stems
The Journal of Arthroplasty, Vol. 17 No. 4 Suppl 1, June 2002 [\(H121\)](#)

Louis M. Kwong, MD, A. John Miller, MD, and Philipp Lubinus, MD

A Modular Distal Fixation Option for Proximal Bone Loss in Revision Total Hip Arthroplasty, A 2- to 6- Year Follow-up Study,
The Journal of Arthroplasty Vol.18 No. 3 Suppl.1 March 2003 [\(H122\)](#)

Daniel J. Berry, MD

Treatment of Vancouver B3 Periprosthetic Femur Fractures With a Fluted Tapered Stem,
Clinical Orthopaedics, No. 417, December 2003, pp. 224-231 [\(H128\)](#)

Stephen M. Murphy, MD, and Jose Rodriguez, MD

Revision Total Hip Arthroplasty With Proximal Bone Loss,
The Journal of Arthroplasty Vol.19 No. 4 Suppl 1 June 2004 [\(H133\)](#)

W. Klauser, P. Lubinus

MP®-Rekonstruktionsprothese (LINK®), Modulare Revisionsendoprothetik des Hüftgelenks,
Sonderdruck aus P. Thümler, R. Forst /Hrsg), Seiten 264-270, Springer-Verlag Berlin Heidelberg, 2004
[\(H130\)](#)

Scott M. Sporer, MD, MS; Wayne G. Paprovsky, MD, FACS

Femoral Fixation in the Face of Considerable Bone Loss,
Clinical Orthopaedics, No. 429, pp 227-231, 2004

Clinical Cases with the LINK® MP® Hip System

Order No.: 664So/4.99L

For more information on surgical technique please ask for our catalog:

664en Surgical Technique

Numerical Index

	page		page
05-1000/01	31	131-386/50	22
05-2001/03	16, 23	131-386/50 to 131-386/87	26
05-2002/03	16, 22	131-388/50	22
		131-388/50 to 131-388/87	27
10-5373	16, 17	131-390/50	22
		131-390/50 to 131-390/87	28
63-4300/02	31	131-392/50	22
63-4300/05	31	131-392/50 to 131-392/87	29
63-4300/11	31	131-393/26, 131-393/35	16, 20
63-4300/19, 63-4300/20	31	131-394/26, 131-394/35	16, 20
63-4300/40	31	131-395/26, 131-395/35	16, 20
		131-396/26, 131-396/35	16, 20
64-4300/30	31	131-397/38, 131-397/58	16, 20
64-8008	16, 21	131-398/10, 131-398/20	16, 20
		131-535/46, 131-535/49	23
65-1700/20, 65-1700/25	30	131-928/01 to 131-928/04	16, 19
		131-932/01 to 131-932/04	16, 19
128-791/01 to 128-793/03	14	131-936/01 to 131-936/04	16, 19
128-826/01 to 128-832/04	14		
128-928/01 to 128-936/03	14	172-900/12 to 172-903/16	11
		172-916/12 to 172-916/25	08
130-408/05	16, 18	172-917/12 to 172-917/25	08
130-600	16, 19	172-918/12 to 172-918/25	08
130-601	19	172-919/12 to 172-919/25	08
		172-921/12 to 172-921/25	08
131-340/04	23	172-922/12 to 172-922/25	08
131-340/05	15	172-925/12 to 172-925/25	08
131-341/08, 131-341/09	16	172-926/12 to 172-926/25	08
131-341/10	23	172-929/14 to 172-929/25	08
131-341/15	15, 16	172-930/14 to 172-930/25	08
131-342/01	15, 22	172-931/14 to 172-931/25	08
131-342/02, 131-342/03	22	172-932/14 to 172-932/25	08
131-343/01	15, 22	172-947/38, 172-947/58	10
131-343/02, 131-343/03	22	172-950/10, 172-950/20	10
131-344/01	15, 23	172-955	14
131-344/02, 131-344/03	23	172-960/26, 172-960/35	09
131-376	16, 21	172-961/26, 172-961/35	09
131-377/01	16, 21	172-962/26, 172-962/35	09
131-378/05, 131-378/06	16, 21	172-963/26, 172-963/35	09
131-378/10, 131-378/11	23	172-964/26, 172-964/35	09
131-378/20	23	172-965/26, 172-965/35	09
131-380/01, 131-380/02	16, 17	172-966/26, 172-966/35	09
131-382/50 to 131-382/87	23, 24	172-967/26, 172-967/35	09
131-383, 131-383/90	16, 18	172-970, 172-975	13
131-384/01 to 131-384/04	16, 18	172-971/10 to 172-974/04	13
131-384/50 to 131-384/87	25		
131-385	16, 18	175-600	31
131-385/01	23	175-870/02 to 175-870/17	30
131-385/10	23	175-870/41, 175-870/51	30

■ Important Information

Please note the following regarding the use of our implants:

1. Choosing the right implant is very important.

The size and shape of the human bone determine the size and shape of the implant and also limit the load capacity. Implants are not designed to withstand unlimited physical stress. Demands should not exceed normal functional loads.

2. Correct handling of the implant is very important.

Under no circumstances should the shape of a finished implant be altered, as this shortens its life span. Our implants must not be combined with implants from other manufacturers.

The instruments indicated in the Surgical Technique must be used to ensure safe implantation of the components.

3. Implants must not be reused.

Implants are supplied sterile and are intended for single use only. Used implants must not be reused.

4. After-treatment is also very important.

The patient must be informed of the limitations of the implant. The load capacity of an implant cannot compare with that of healthy bone!

5. Unless otherwise indicated, implants are supplied in sterile packaging.

Note the following conditions for storage of packaged implants:

- Avoid extreme or sudden changes in temperature.
- Sterile implants in their original, intact protective packaging may be stored in permanent buildings up until the "Use by" date indicated on the packaging.
- They must not be exposed to frost, dampness or direct sunlight, or mechanical damage.
- Implants may be stored in their original packaging for up to 5 years after the date of manufacture. The "Use by" date is indicated on the product label.
- Do not use an implant if the packaging is damaged.

6. Traceability is important.

Please use the documentation stickers provided to ensure traceability.

7. Further information on the material composition is available on request from the manufacturer.

Follow the instructions for use!

Waldemar Link GmbH & Co. KG, Hamburg

All content in this catalog, including text, pictures and data, is protected by law. Every instance of use, whether in part or in whole and which is not permitted by law, is subject to our prior consent. In particular, this applies to the reproduction, editing, translation, publishing, saving, processing, or passing on of content stored in databases or other electronic media and systems, in any manner or form. The information in the catalogs is solely intended to describe the products and does not constitute a guarantee.

The Surgical Technique described has been written to the best of our knowledge and belief, but it does not relieve the surgeon of his/her responsibility to duly consider the particularities of each individual case.



Waldemar Link GmbH & Co. KG

Barkhausenweg 10 · 22339 Hamburg, Germany
P.O. Box 63 05 52 · 22315 Hamburg, Germany
Tel.: +49 40 53995-0 · Fax: +49 40 5386929
E-mail: info@linkhh.de · www.linkorthopaedics.com

LINK[®]

